



O P E R A T I N G
M A N U A L

slee solutions
for
pathology

ERGOTEC

WORKTABLE

DESIGN &
MANUFACTURING
MADE IN GERMANY

Dear Customer,

thank you very much for your confidence in SLEE products!

Before you start operating the device, please read the operating instructions carefully to familiarize yourself with the proper operation and functions. The device should only be operated by specially trained and instructed staff. The specified safety measures as well as the regulations and hygiene standards of the respective laboratories must be respected.

Enjoy working with your new device!

Your team from SLEE medical GmbH

Please note:

Some of the images in this manual may show special equipment and / or accessories that are subject to a charge. The image may differ slightly from the product. Errors excepted.

We always try to keep our documents up-to-date and free of errors. However, should you notice any mistakes, we would be grateful if you could provide us with feedback. Comments on the actual content are also welcome at any time. Simply e-mail us at marketing@slee.de.

The information, numerical data and notes contained in this document represent the current state of scientific knowledge and state-of-the-art technology as we understand it following thorough investigation in this field. SLEE medical GmbH is under no obligation to update the present manual periodically and on an ongoing basis according to the latest technical developments, nor to provide our customers with additional copies, updates etc. of this document. To the extent permitted in accordance with the national legal system as applicable in each individual case, we shall not be held liable for erroneous statements, drawings, technical illustrations etc. contained in this document. In particular, no liability whatsoever is accepted for any financial loss or consequential damage caused by or related to compliance with statements or other information in this document. Statements, drawings, illustrations and other information regarding the contents or technical details are not to be considered warranted characteristics of our products. These are determined only by the contract provisions agreed between ourselves and our customers. SLEE medical GmbH reserves the right to change technical specifications as well as manufacturing processes without prior notice.



CONTENTS

1	PURPOSE OF THE DEVICE	7
2	SYMBOLS	7
3	OVERVIEW DEVICE	8
4	SAFETY NOTES	9
5	PARTS	9
6	SPECIFICATIONS	10
7	INSTALLATION	11
8	USE OF THE ERGOTEC WORKPLACE	11
8.1	Setting of table height	11
8.2	Cooling plate (optional)	12
8.3	Water bath (optional)	15
9	CLEANING AND MAINTENANCE	18
9.1	Cleaning	18
9.2	Recommended maintenance and service schedule	18
10	OPTIONAL ACCESSORIES	18
11	SERVICE	19
12	WARRANTY	19
13	DISPOSAL	19

1 PURPOSE OF THE DEVICE

Workplaces must increasingly meet good ergonomics. The Slee ergonomic worktables comply with good ergonomics using electrically height-adjustable parts. The height adjustment can be stored electronically and can easily be recalled, allowing the user to easily adjust the desired working height.

2 SYMBOLS

	<p>Dangers, warnings and cautions are marked by this symbol.</p>
	<p>Special instructions regarding the operation of the device are marked by this symbol.</p>
	<p>Mechanical components that can lead to injuries during operation are marked with this symbol.</p>

3 OVERVIEW DEVICE

Monitor arm /
PC workstation
(optional)

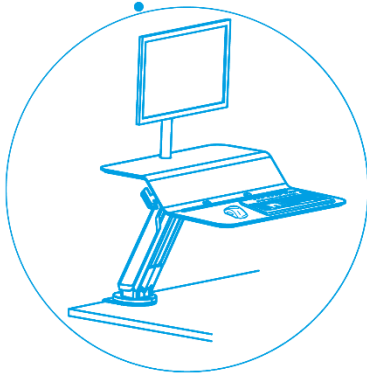

Workplace lighting (optional)

Cooling plate
(optional)

Water bath (optional)

Cable channel
(optional depending
on table configuration)

Undertable drawer
(optional)

Adjustable height -
motorized (optional)

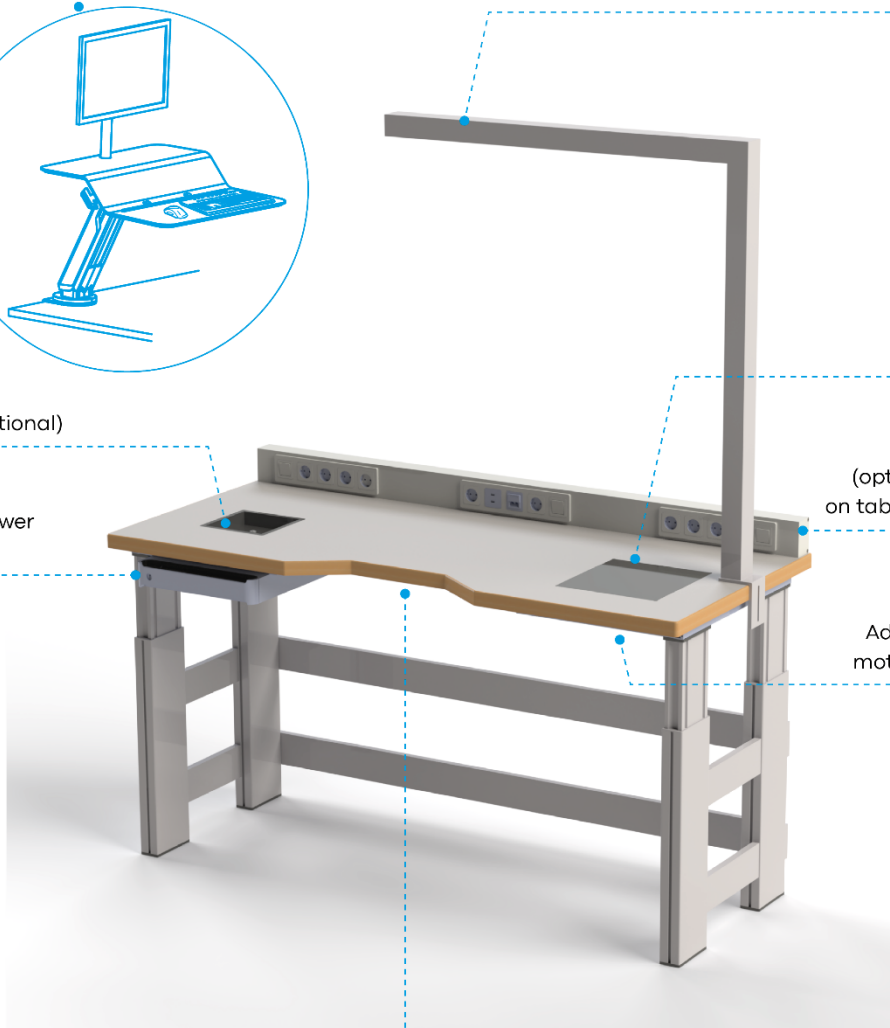

Ergonomic cutout
(optional)

4 SAFETY NOTES

The institution that owns the device and the people who work with it are responsible for safe use.

5 PARTS

	Ergotec
Basic table	•
Ergonomic cutout	(optional)
Cooling plate	(optional)
Water bath	(optional)

6 SPECIFICATIONS

Ergotec table	
Nominal supply voltage	230 V AC +/-10 %
Nominal frequency	50/60 Hz
Power consumption	360 VA
Protection class ⁽¹⁾	I
Fuses Ergotec w. cooling plate and water bath	T 2.5 A – 230 V – 50/60 Hz
	T 4.0 A – 115 V – 60 Hz
Pollution degree ⁽¹⁾	I
Installation category for over voltage	2
Working temperature	+10 up to +35 °C
Relative humidity	max. 80 % rel., non-condensing
Storage temperature	+5 up to +55 °C
Humidity during storage	max. 80 % rel., non-condensing
Weight capacity	max. 400 kg
Height adjustment	74 - 110 cm

⁽¹⁾ According to IEC 1010, EN 61010

Cooling plate	
Dimensions (cooling area)	295 x 315 mm
Dimensions (border)	325 x 345 mm
Temperature range	down to -15 °C max., -5 °C default setting
Dimensions aggregate under the table	320 x 300 x 180 mm
Power consumption	470 VA

Water bath	
Dimensions (bath)	193 x 193 x 60 mm
Dimensions (border)	240 x 240 mm
Temperature range	room temperature up to 85 °C, +45 °C default setting
Dimensions container under the table	240 x 280 x 100 mm
Length drain pipe	30 mm
Power consumption	120 VA

7 INSTALLATION

The device must be placed on a flat, vibration-free surface.

Connect the mains cable.

8 USE OF THE ERGOTEC WORKPLACE

8.1 Setting of table height

Only applicable for tables with height adjustment. Please note that the display will fade when not in use.

Adjust table height:

Press , to raise the table.





Press , to move the table down.

The columns move as long as the button is pressed.

Info: The height may be set from 74 up to 110 cm. The table has a lower reference point for service purposes only.

Set table height:

Move the table with the  /  button to the desired height.





Press one of the memory keys     4 x to save the current height.

Successful position saving will be confirmed by the number of beeps corresponding with the selected memory

key number, e. g. to save position , press  4 x. It will beep 1 x to confirm the setting.

Tip: Press the buttons quickly. If they are pressed too slowly, the position will not be saved.

Recall stored height settings:

Press one of the memory keys     until the table stops at the stored position.



There is a risk of crushing when changing the table height.

8.2 Cooling plate (optional)

Display of the cooling plate:

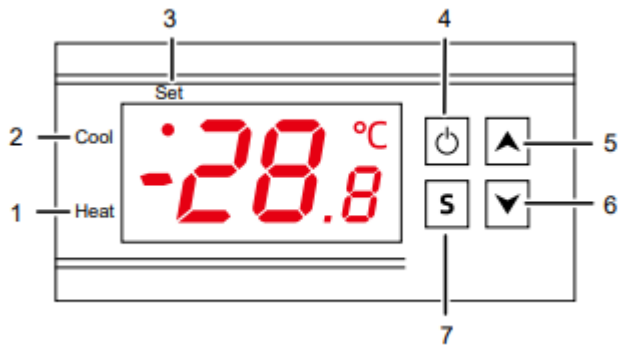

[1 Heating status (not applicable)]

2 Cooling status

3 Settings mode indicator

4 Power On / Off button

5 Up button

6 Down button

7 Set button



Status indicators

Indicator	Description
Cool	ON: Cooling on, OFF: Cooling off, Flashing: Compressor delay is active.
Set	ON: Settings mode is active.

Button controls

Button	Name	Description
	Power	Press to switch the power ON. Press and hold to switch the power OFF.
	Up / Down	Increase / Decrease
	Settings	Press and hold to enter "settings mode". Change values in "settings mode": Press and hold S , then press / to adjust settings.



Power ON / OFF

We highly recommend to command the cooling plate via  .
 (The button of the display is fully functional when the power is on, but it is more comfortable to control the cooling plate via the button  on the cable channel.)

Turn the cooling plate on by switching the button  .
 The display will flash for a few seconds and then show the current room temperature.
 Then the cooling plate cools down to the set temperature, which is -5 °C by default.
 You may hear the relay “click” when switching the power on or off. This is normal.
 When the power is off, the display switches off and no temperature control takes place.

Setting of the desired temperature:

If you wish to change the default temperature (-5 °C) enter settings mode by pressing and holding **S**.

The set temperature will be displayed. It can be adjusted by pressing **S** and  or  .





As it is cooling down, the status “Cool” on the left side is active.

System settings

Settings	Description
F1	Target temperature Range: -50 to +99 °C, default: -5 °C <ul style="list-style-type: none"> An alarm will sound when the temperature exceeds the target temperature.
F2	Difference value (hysteresis) Range: 1 to +10 K, default: 1.5 K <ul style="list-style-type: none"> Cooling switches ON when: Measured temperature \geq [(target temperature) + (difference value)].
F3	Compressor delay Range: 1 - 10 min, default: 0 min <ul style="list-style-type: none"> This is a time delay between when the target temperature is reached and before the relay activates cooling. It prevents the cooling system from restarting too quickly after stopping. This is to minimize wear and tear on cooling systems.
F4	Temperature offset (calibration) Range: -10 to +10 K, default 0 K <ul style="list-style-type: none"> Measure the temperature using an external thermometer and compare result with the temperature shown on the product. Offset any discrepancy between the measured result and what is shown on the product.

Preconditions:

The product is connected to the power supply and switched ON.

1. Press and hold **S** to enter settings mode.
 2. Press  or  to toggle through settings.
 3. Press and hold **S**, then press  or  to adjust settings.
 4. Press  to save the settings and return to the main screen.
- If no keys are pressed for 10 seconds, the settings menu will close (unsaved).
→ System settings will be saved after power OFF.

Error codes

Code	Description
EE	Fault: Open circuit or short circuit <ul style="list-style-type: none">• Alarm will sound and all power will be cut off.• Press any button to cancel the alarm.• Normal operation will resume when the conditions triggering the error are removed.
HH	Fault: Max. temperature (99 °C) exceeded. <ul style="list-style-type: none">• Alarm will sound and all power will be cut off.• Press any button to cancel the alarm.• Normal operation will resume when the conditions triggering the error are removed.

Troubleshooting

The cooling plate does not become evenly cold.	The condenser can be clogged.	Make it dust free.
	The cooling system is leaking or blocked.	Contact your supplier.
The cooling plate does not reach the set temperature.	Leak in cooling system.	
The cooling plate no longer cools at all.	Compressor defective.	

8.3 Water bath (optional)

Display of the water bath:

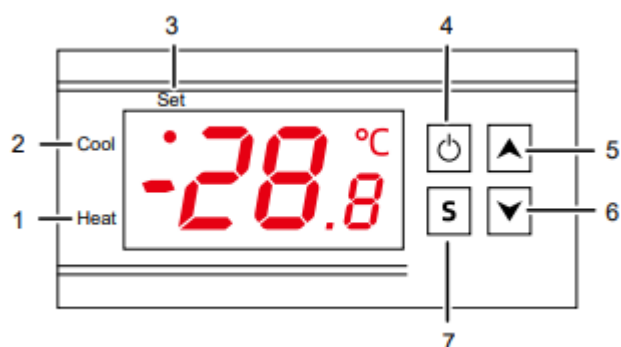

1 Heating status

[2 Cooling status (not applicable)]

3 Settings mode indicator

4 Power On / Off button

5 Up button





6 Down button

7 Set button

Status indicators

Indicator	Description
Heat	ON: Heating on, OFF: Heating off.
Set	ON: Settings mode is active.

Button controls

Button	Name	Description
	Power	Press to switch the power ON.
		Press and hold to switch the power OFF.
	Up / Down	Increase / Decrease
	Settings	Press and hold to enter "settings mode".
		Change values in "settings mode": Press and hold S , then press  to adjust settings.

Power ON / OFF

We highly recommend to command the water bath via .

(The button of the display is fully functional when the power is on, but it is more comfortable to control the water bath via the button  on the cable channel.)

Turn the water bath on by switching the button .

The display will flash for a few seconds and then show the current room temperature.



Then the water bath heats up to the set temperature, which is +45 °C by default.

You may hear the relay "click" when switching the power on or off. This is normal.

When the power is off, the display switches off and no temperature control takes place.

Setting of the desired temperature:

If you wish to change the default temperature (+45 °C) enter settings mode by pressing and holding **S**.

The set temperature will be displayed. It can be adjusted by pressing **S** and  or .





As it is heating up, the status "Heat" on the left side is active.

System settings

Settings	Description
F1	Target temperature Range: -50 to +99 °C, default: +45 °C
F2	Difference value (hysteresis) Range: 1 to +10 K, default: 3 K <ul style="list-style-type: none">Heating switches ON when: Measured temperature \leq [(target temperature) - (difference value)].
F3	Delay Range: 1 - 10 min, default: 0 min <ul style="list-style-type: none">This is a time delay between when the target temperature is reached and before the relay activates heating.It prevents the heating system from restarting too quickly after stopping. This is to minimize wear and tear on heating systems.
F4	Temperature offset (calibration) Range: -10 to +10 k, Default 0 K <ul style="list-style-type: none">Measure the temperature using an external thermometer and compare result with the temperature shown on the product.Offset any discrepancy between the measured result and what is shown on the product.

Preconditions:

The product is connected to the power supply and switched ON.

1. Press and hold **S** to enter settings mode.
 2. Press  or  to toggle through settings.
 3. Press and hold **S**, then press  or  to adjust settings.
 4. Press  to save the settings and return to the main screen.
- If no keys are pressed for 10 seconds, the settings menu will close (unsaved).
- System settings will be saved after power OFF.

Error codes

Code	Description
EE	Fault: Open circuit or short circuit <ul style="list-style-type: none"> • Alarm will sound and all power will be cut off. • Press any button to cancel the alarm. • Normal operation will resume when the conditions triggering the error are removed.
HH	Fault: Max. temperature (99 °C) exceeded. <ul style="list-style-type: none"> • Alarm will sound and all power will be cut off. • Press any button to cancel the alarm. • Normal operation will resume when the conditions triggering the error are removed.

Troubleshooting

The temperature in the water bath becomes warmer than the set temperature.	Problem with the thermal fuse.	Contact your supplier.
	Defect in the display.	

9 CLEANING AND MAINTENANCE

9.1 Cleaning

The table top should be cleaned regularly with lukewarm water.

The table legs must be cleaned of dust and dirt every six months. This can be done with a dust cloth.



Wear protective clothing and disposable gloves following GLP.

Do not use chemicals to clean the device.

Only use alcohol-based agents.

9.2 Recommended maintenance and service schedule

Daily	Remove waste after use.
Weekly	Clean the table top.
Semiannually	Clean table legs.
Annually	The condenser of the cooling plate must be made dust-free (this can be done with a vacuum cleaner).

10 OPTIONAL ACCESSORIES

Description	Item No.
Ergonomic cutout	upon request
Cooling plate	upon request
Water bath	upon request
LED lamp	10120005
Ergosit laboratory chair - high	10157011
Ergosit laboratory chair - low	10157001
Drawer	10120006
Cable channel - according to configuration	upon request
Monitor arm	(optional)10120004
Radio	upon request

11 SERVICE

Internal components should only be serviced by technicians authorized by SLEE medical GmbH.

If technical service or spare parts are necessary, please contact your local SLEE medical GmbH distributor. Please have the following information available:

- complete contact details,
- type of device and serial number,
- location of device and name of user,
- purpose of service call,
- delivery date of the unit.

If it is necessary to return the device, it must be cleaned and disinfected before delivery. It must be returned in its original packing.

If the device or parts thereof are sent back in a dirty or non-disinfected condition, SLEE medical GmbH reserves the right to return the parts to the debit of the customer.

12 WARRANTY

SLEE medical GmbH guarantees that the product delivered has been subjected to a comprehensive quality control procedure, and that the product is faultless and complies with all technical specifications and / or agreed characteristics warranted.

SLEE medical GmbH guarantees that the device is manufactured under an ISO 9001:2015 and ISO 13485:2016 quality management system.

Unauthorized modification or repair by third party persons will void the warranty.

Only original SLEE medical GmbH spare parts must be used.

Guarantee claims can be put forward only if the device is used according to this manual and for the purpose described.

Mistakes and errors which occur because of improper use cannot be accepted.

13 DISPOSAL

The device or parts of the device must be disposed of according to existing local applicable regulations.



SLEE medical GmbH · Am Neuberg 14
55268 Nieder-Olm · Germany
www.slee.de

T: +49 (0) 6136 76997-0
E: mail@slee.de



www.slee.de



YouTube



LinkedIn



Instagram